

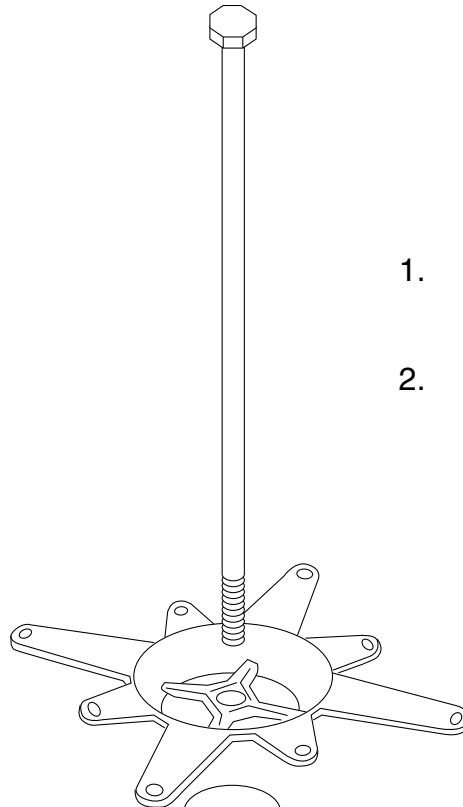

Assembly Instructions

AS26



1. Place bolt through spider, column and cross member.
2. Screw nut onto bolt under the cross member and tighten.

Parts:

- (1) 001-001-000002-00 13" Spider
- (1) 001-002-000007-01 25" x 3" Column
- (1) 001-003-000001-00 27 1/8" x 5/8" Bolt
- (1) 001-006-000001-00 5/8" Nut
- (1) 001-005-120102-01 26" AS Cross member
- (4) 001-004-000001-00 1/2" Plastic Glides
- (8) 001-007-000001-00 #12 x 3/4" Screws

Hint: Turn base upside down to assemble

Warning: Screws provided are for tops at least 1" thick

